

# Optimization of Techniques for Lambda Hyperon Measurement at MPD/NICA.

D. Suvarieva<sup>1,2</sup>, *V. Vasendina*<sup>1</sup>, *A. Zinchenko*<sup>1</sup>  
(For the MPD Collaboration)

*1– Joint Institute for Nuclear Research  
Dubna, Moscow region, Russia*

*2– Plovdiv University "Paisii Hilendarski"  
Plovdiv, Bulgaria*



# Outline

- ✓ Motivation
- ✓ Multi-Purpose Detector – Stage-1
- ✓ Lambda-hyperon reconstruction technique:  $\Lambda^0 \rightarrow \mathbf{p} + \pi^-$
- ✓ Background evaluation approaches
- ✓ Reconstruction of  $p_T$  – spectra of lambda-hyperons
- ✓ Conclusions and outlook

# Physics motivation

- ✓ Hyperons (especially  $\Lambda$ ) are produced in relatively large quantities and have very attractive experimental features (resonance structure and simple decay mode). They can serve as detector performance monitoring tools.
- ✓ Heavy strange objects could provide essential signatures of the excited and compressed baryonic matter.
- ✓ Study of hyperons helps to understand strong interactions and QGP.

# The goal of this study

- ✓ To develop and evaluate background estimation techniques for its accurate determination (especially important at the start-up of the experiment when the amount of data is rather limited).
- ✓ To test hyperon multiplicity determination procedures from background-subtracted invariant mass distributions.

# Multi-Purpose Detector general view

**Time-Projection Chamber (TPC)** is the main tracking detector

**Time-Of-Flight system (TOF)** will be used for particle identification via time-of-flight

**Electromagnetic Calorimeter (Ecal)** will be used for photon and electron measurements,

**Forward Hadron Calorimeter (FHCAL)** will measure centrality and event plane,

**Forward Detector (FD)** will produce the fast trigger for **TOF**

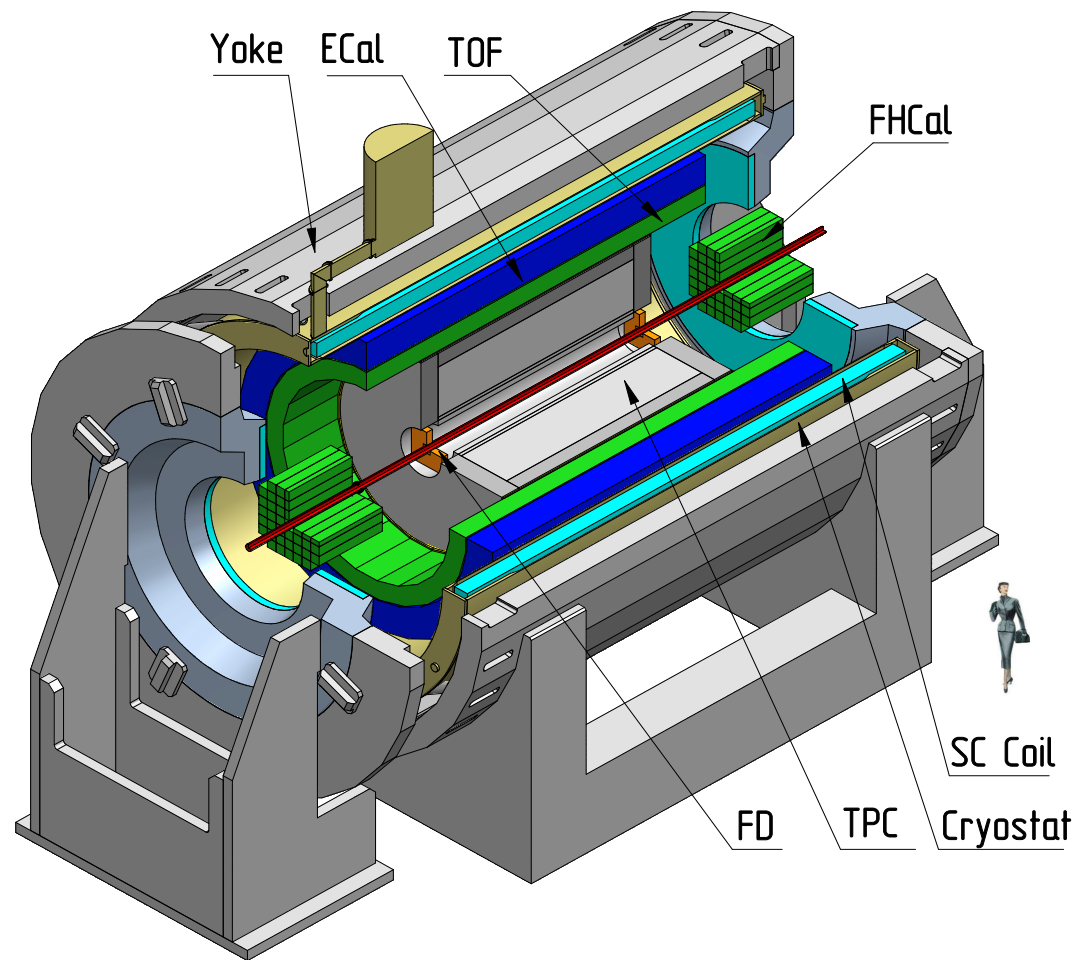

All the subdetectors are located inside a superconducting solenoid.

✓ <http://mpd.jinr.ru/mpd/>

# Data Set

- ✓ **Generators:** UrQMD Au+Au @ 9A GeV central (0 -- 3 fm), 10k events for procedure testing and tuning
- ✓ **Generators:** UrQMD Bi+Bi @ 9.2A GeV minimum bias 20M for multiplicity determination
- ✓ **Detectors:** MPD (TPC+TOF)

# Reconstruction and Analysis

- ✓ Track acceptance criterion:  $N_{\text{hits}} \geq 10$
- ✓ Selection cuts for maximization of significance of the invariant mass peak of hyperon decay products  $S/\sqrt{(S+B)}$
- ✓ Event Mixing method
- ✓ Like-sign pairs

# Reconstruction Method: Secondary Vertex Finding Technique

- **PV** – primary vertex
- **V<sub>0</sub>** – vertex of  $\Lambda$  decay
- **dca** – distance of the closest approach
- **path** – decay length

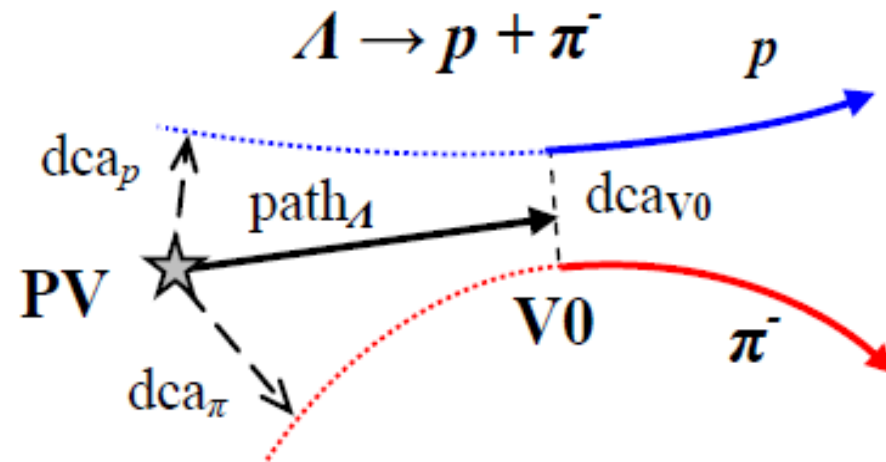

**Maximization of significance:** Significance is defined as  $S/\sqrt{S+B}$ , where **S** and **B** are the total numbers of signal and background combinations inside  $\pm 2\sigma$  interval around the invariant mass peak position ( $\sigma$  is taken from Gaussian fit of the peak).

## **Event mixing method:**

- mix tracks from different events to break track to track correlation
- each event mixed with 3 other events, for our study, the proton from the current event is combined with the pion minus from the previous event.
- the same contamination from PID
- high statistics

## **Like-sign pairs:**

- combine two positive or two negative tracks (like-sign pairs), for our study for lambda hyperons we combine proton and pion plus in the same event
- takes into account correlated effects
- limited statistics

# Event Mixing & Like sign pairs

UrQMD, Au+Au @ 9A GeV, central (0 -- 3 fm), 10k events

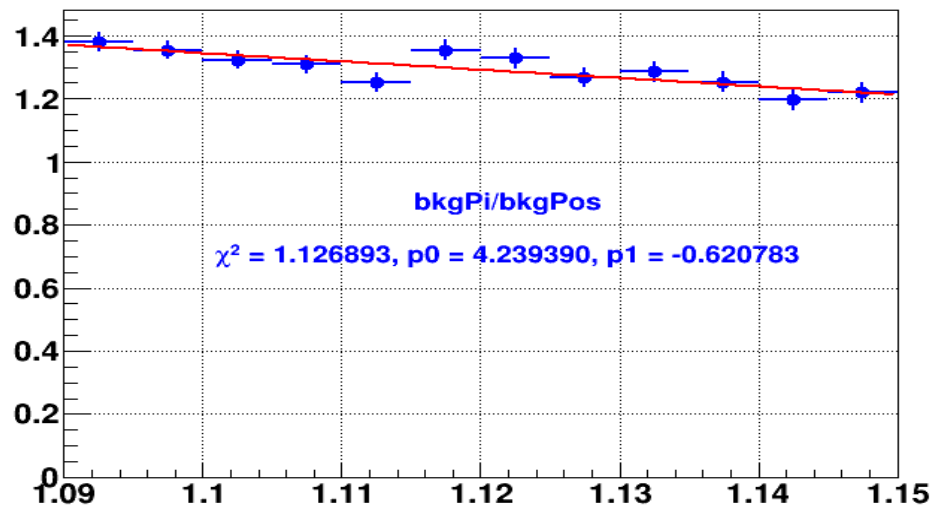
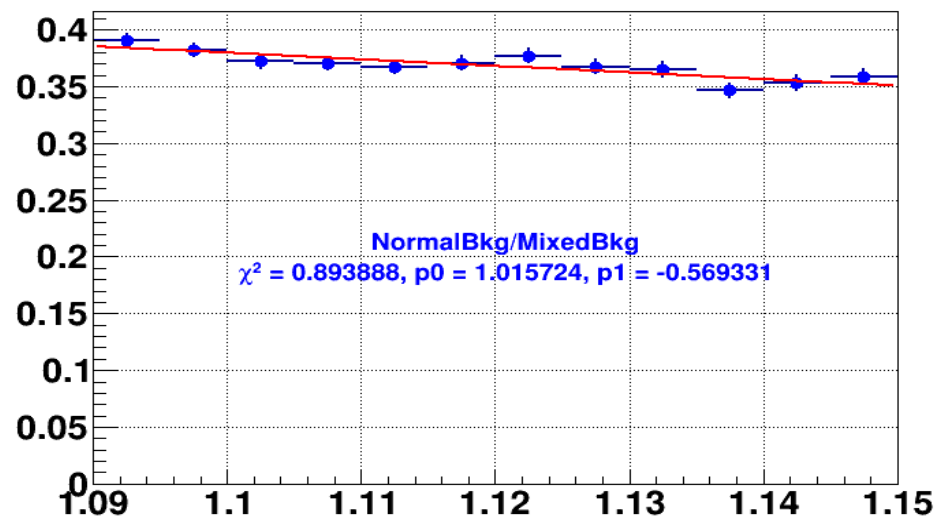
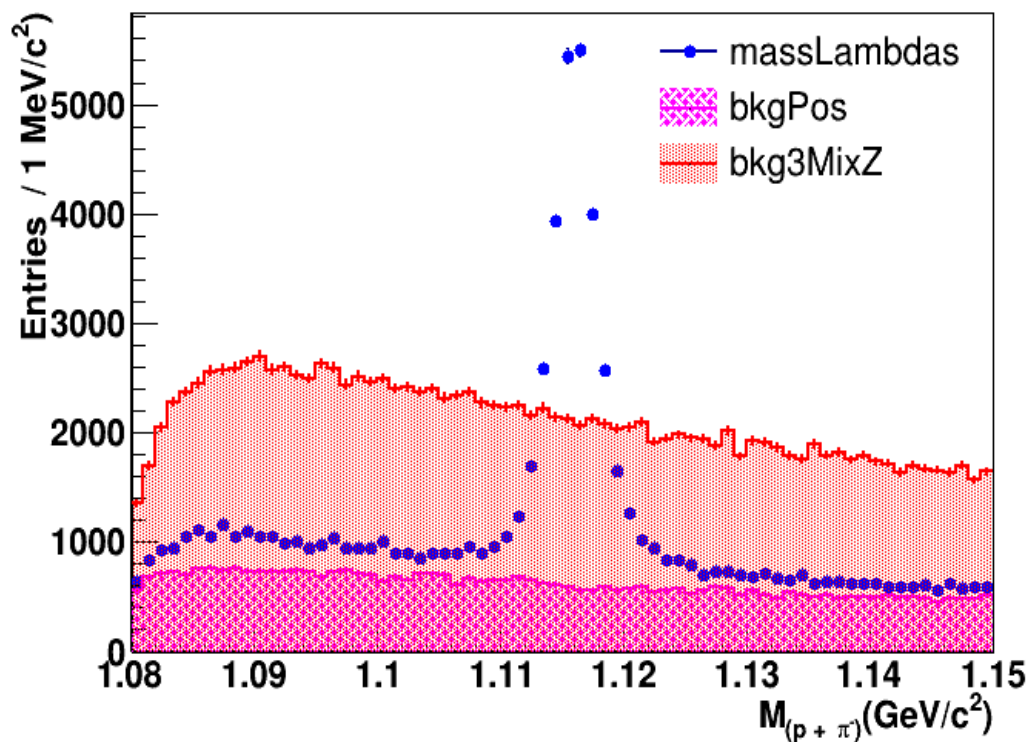



# Step-by-step use of the “Event mixing procedure” for background subtraction

UrQMD, Au+Au @ 9A GeV, central (0 -- 3 fm), 10k events

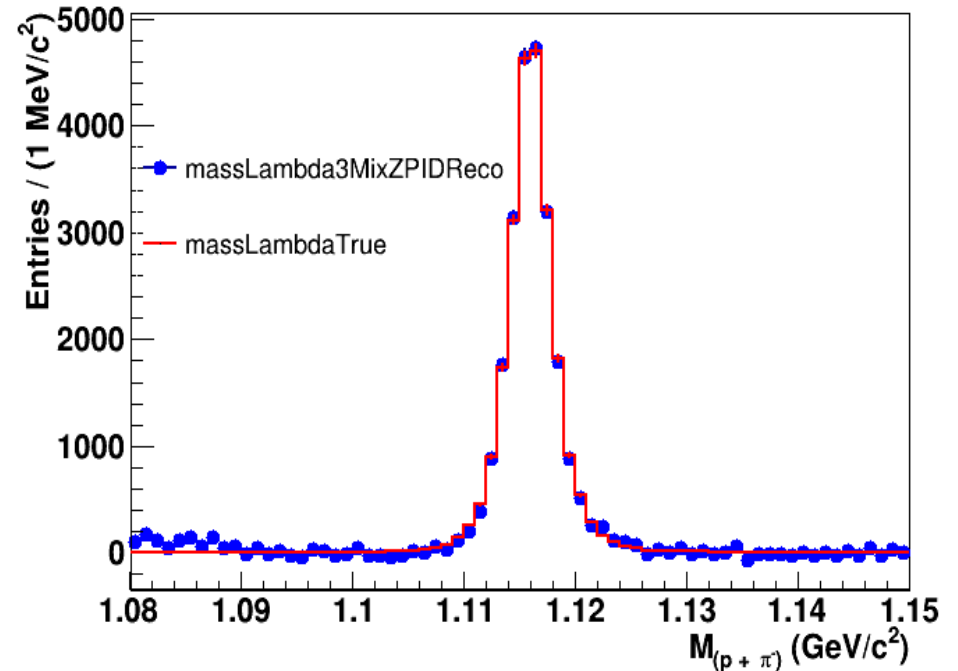
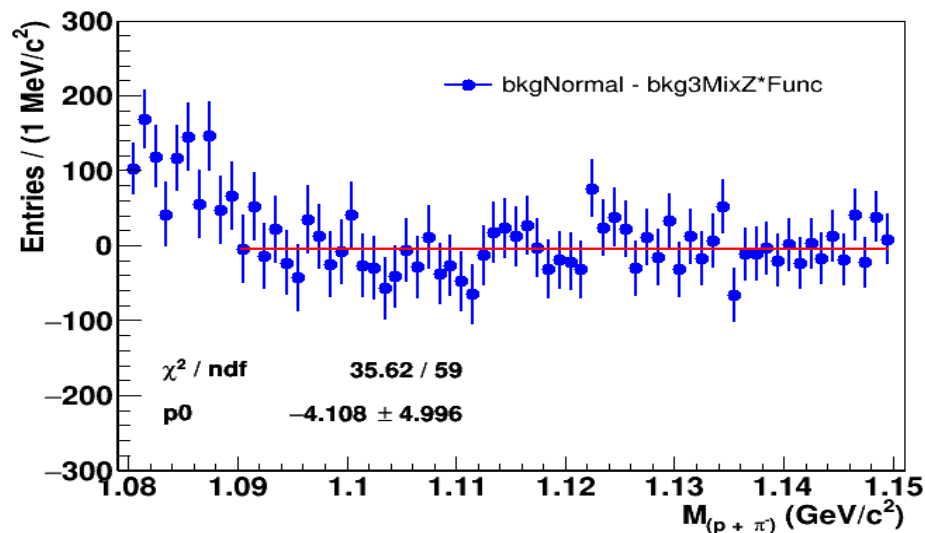
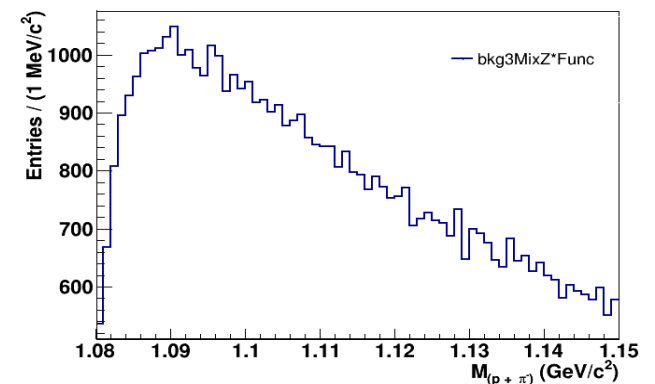
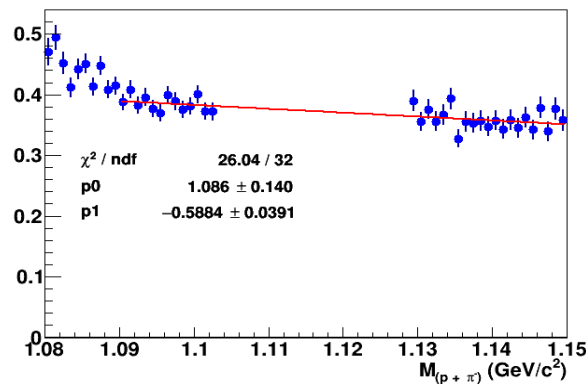
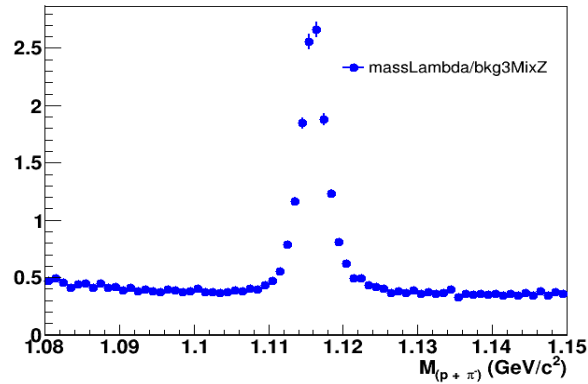

# Event Mixing for different regions of $p_T$

UrQMD, Au+Au @ 9A GeV, central (0 -- 3 fm), 10k events

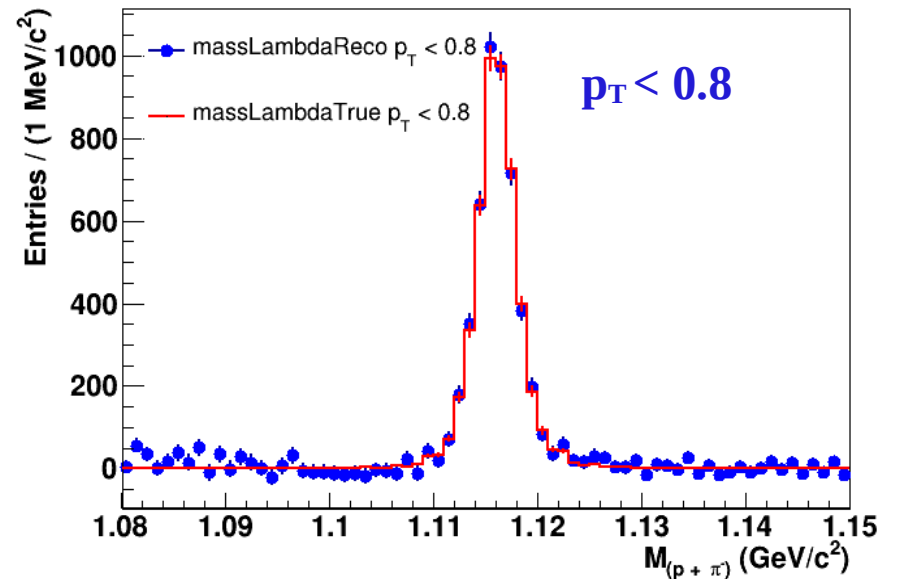
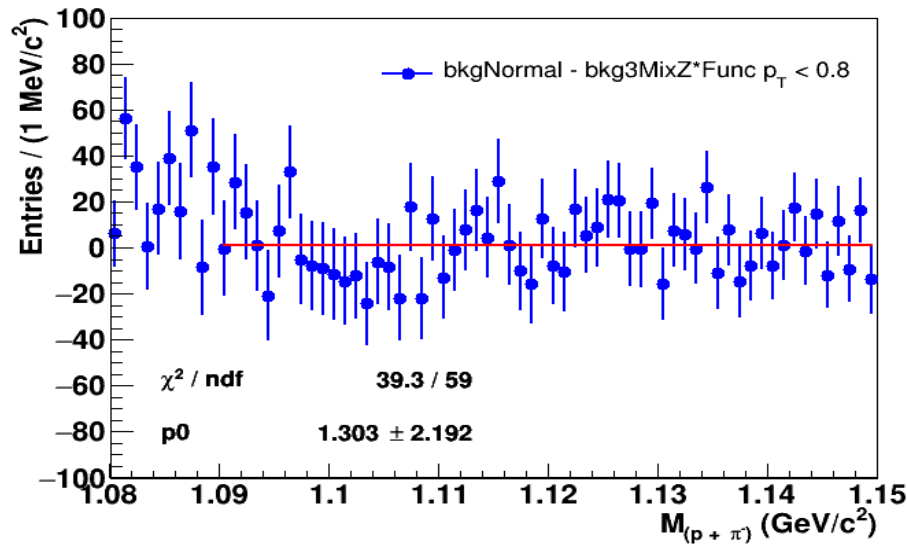
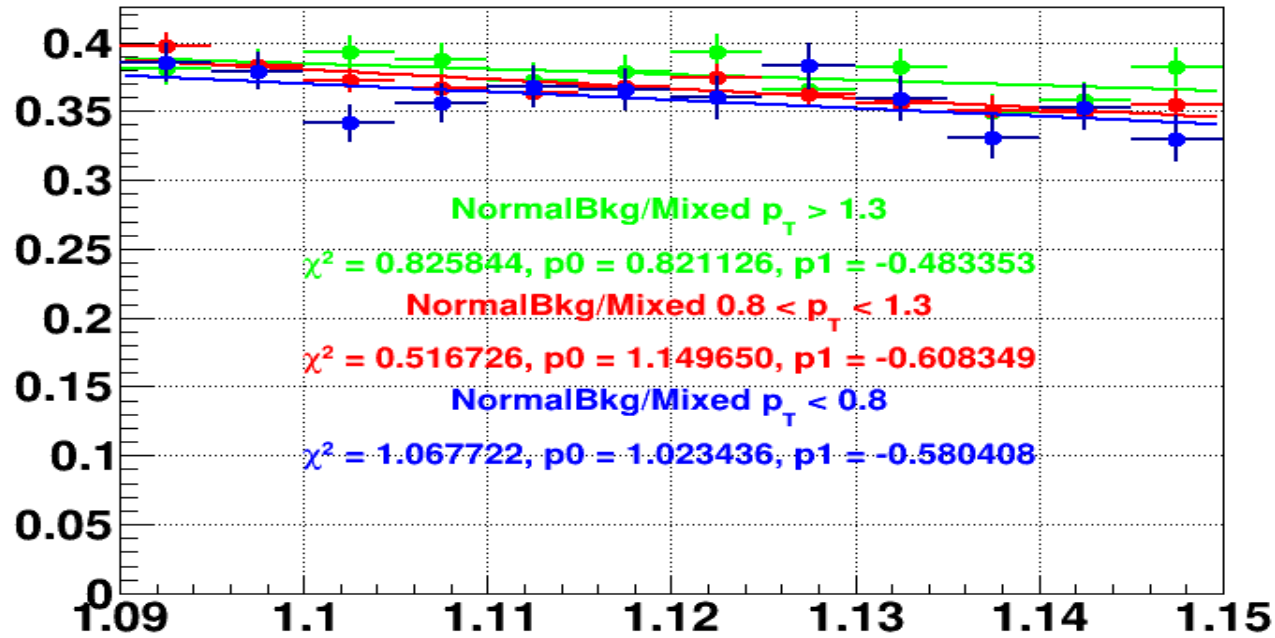

# Event Mixing for different regions of $p_T$

UrQMD, Au+Au @ 9A GeV, central (0 -- 3 fm), 10k events

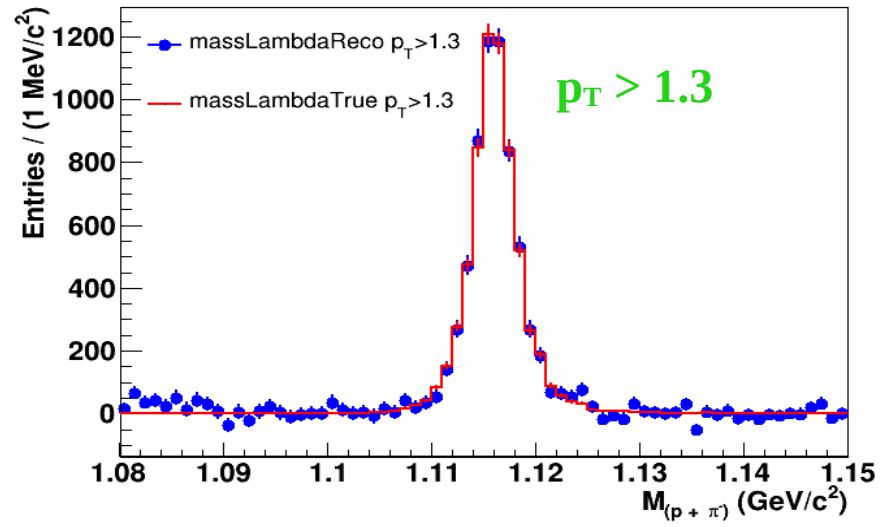
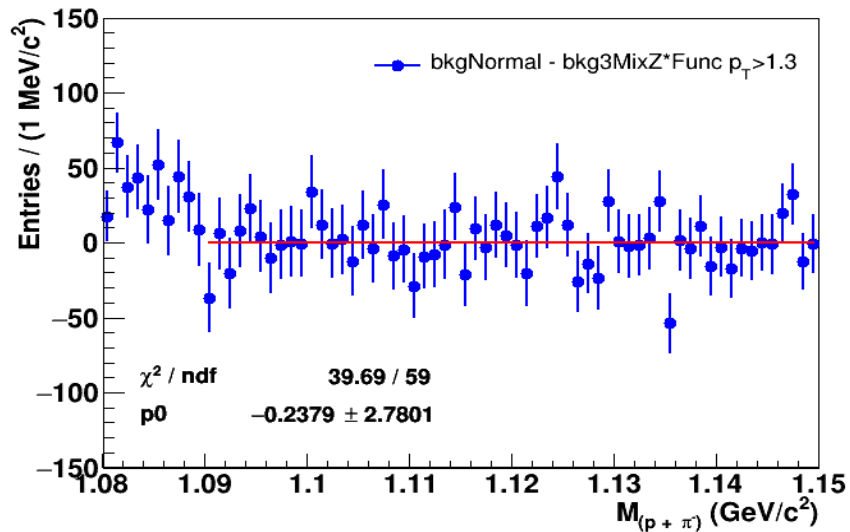
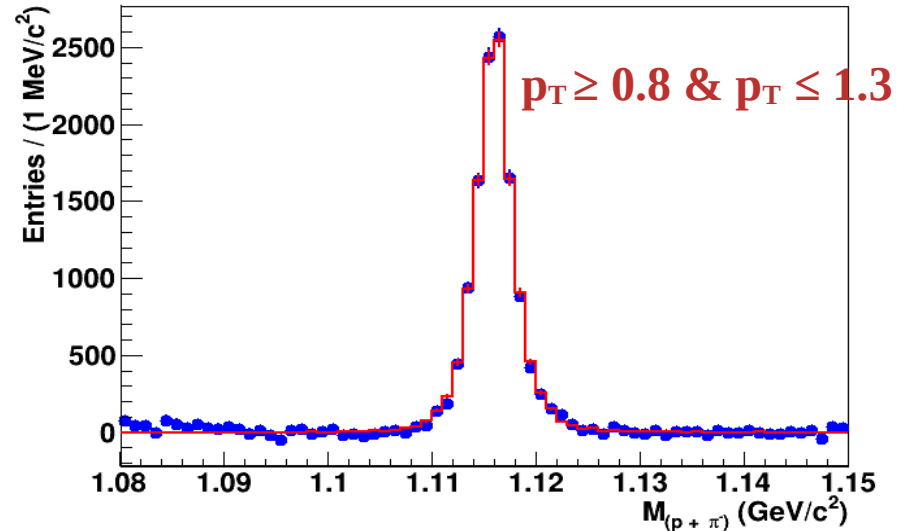
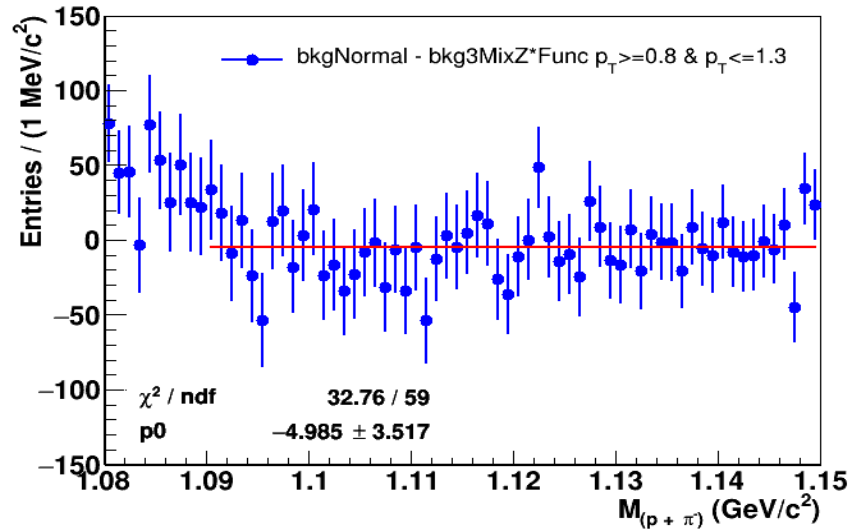

# Step-by-step use of the “Like-sign pairs” for background subtraction

UrQMD, Au+Au @ 9A GeV, central (0 -- 3 fm), 10k events

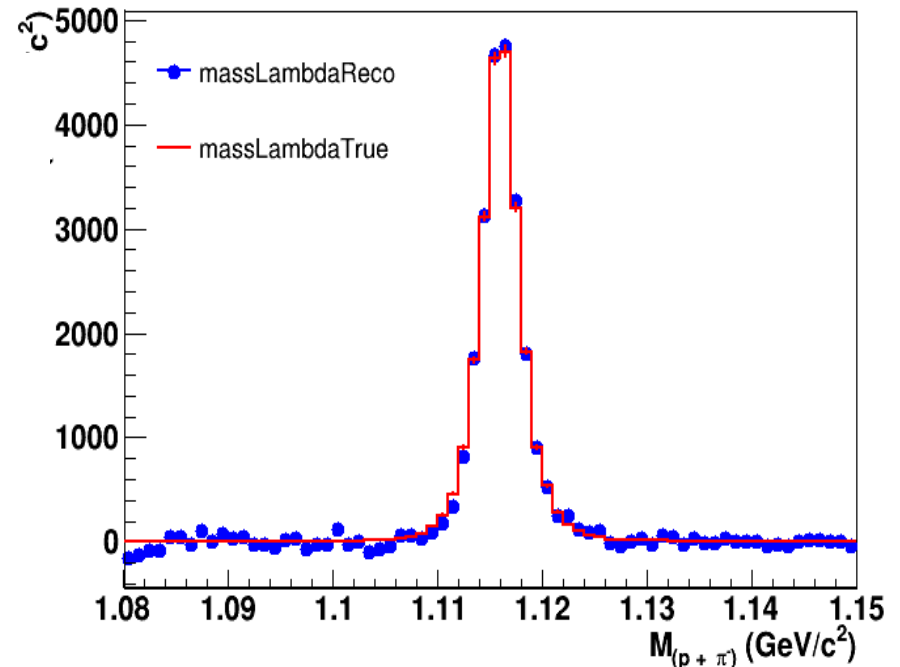
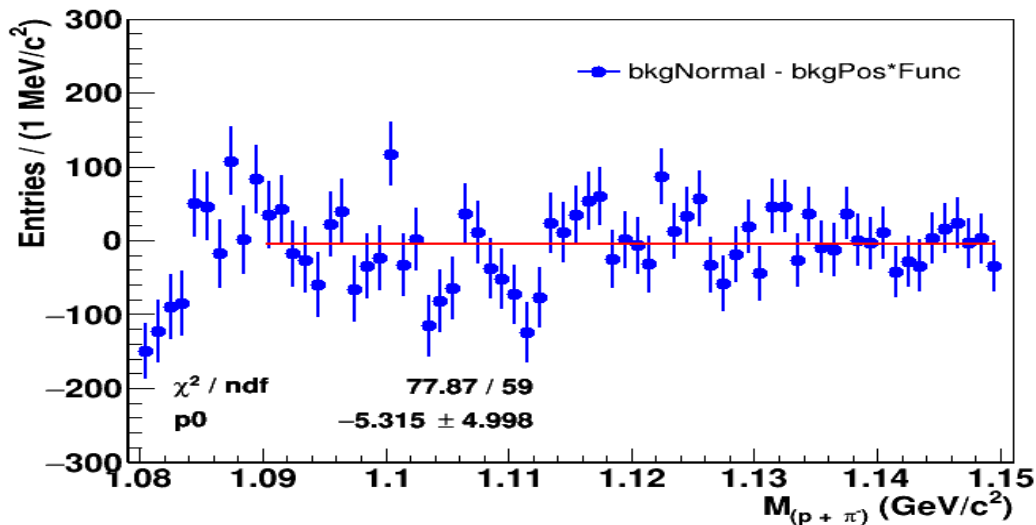
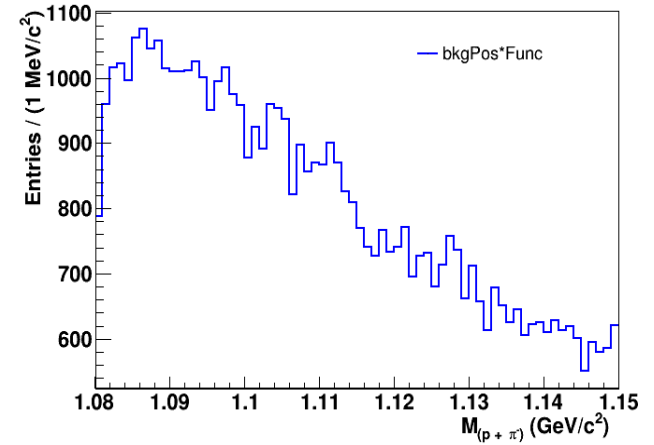
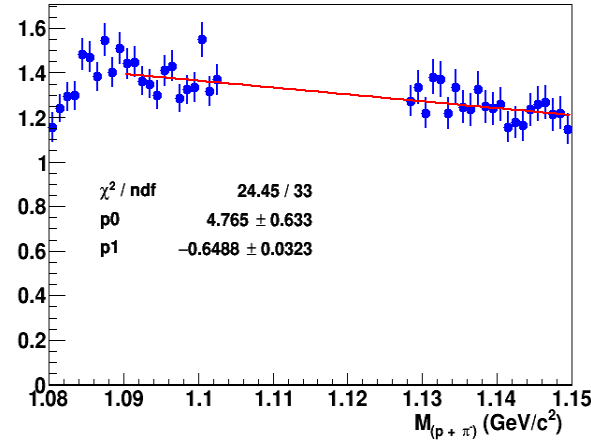
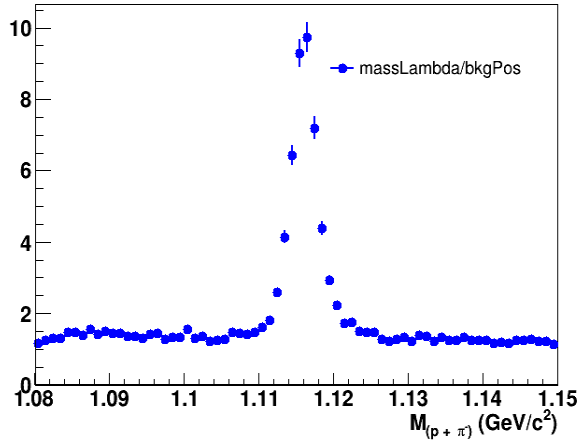

# Like-sign pairs for different regions of $p_T$

UrQMD, Au+Au @ 9A GeV, central (0 -- 3 fm), 10k events

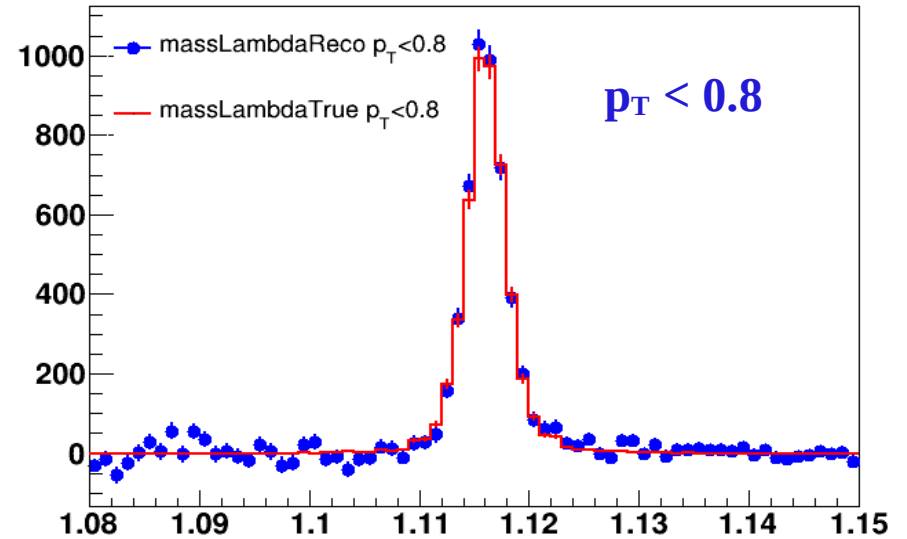
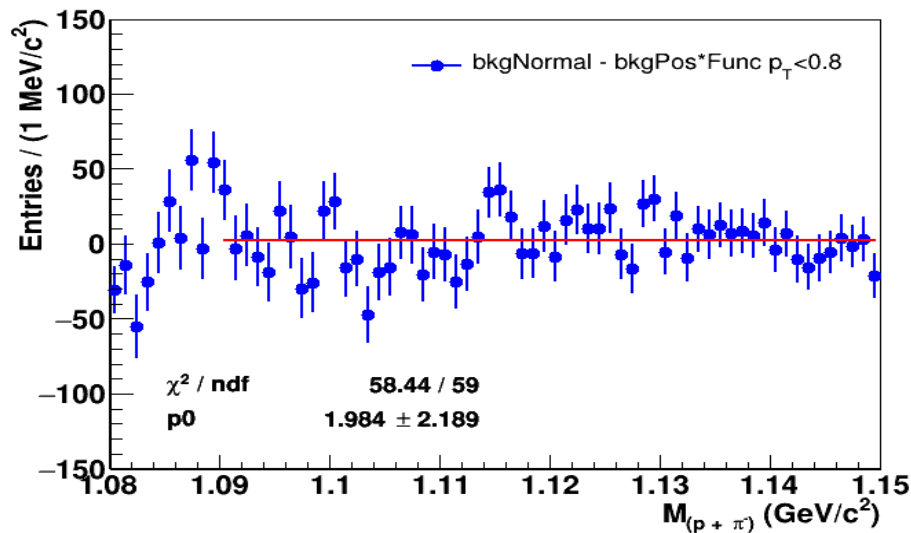
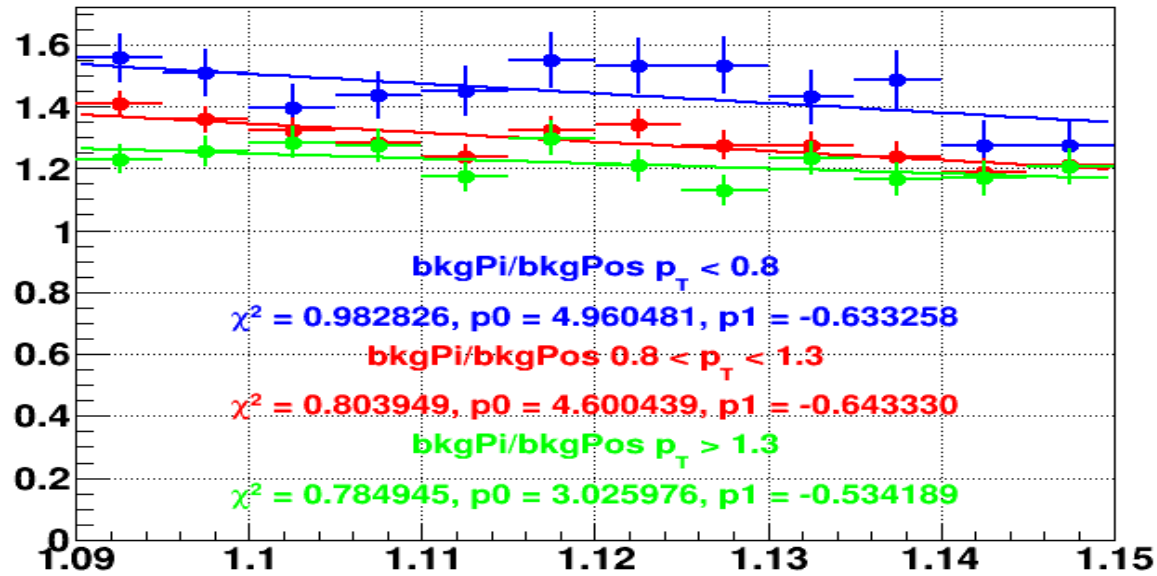

# Like-sign pairs for different regions of $p_T$

UrQMD, Au+Au @ 9A GeV, central (0 -- 3 fm), 10k events

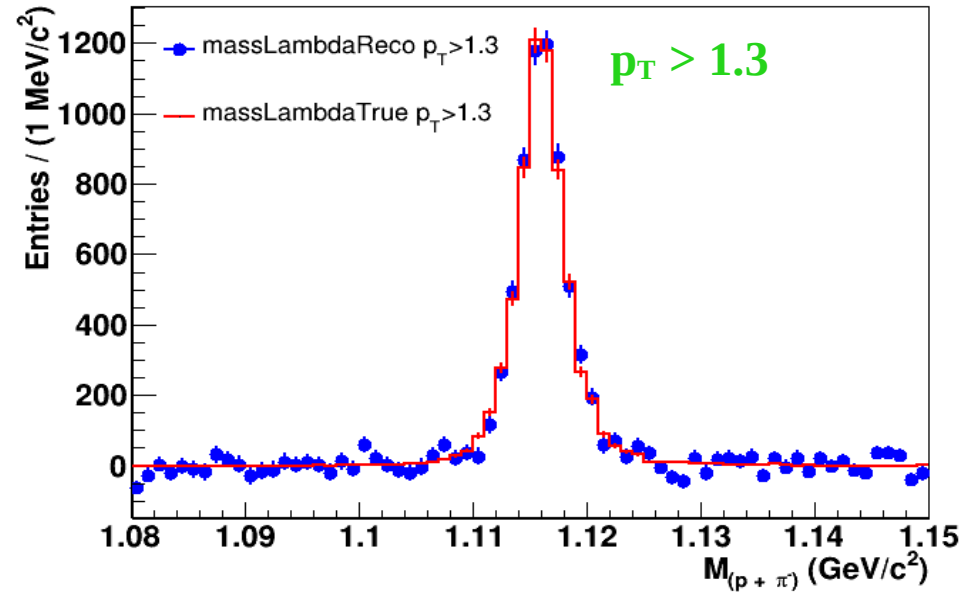
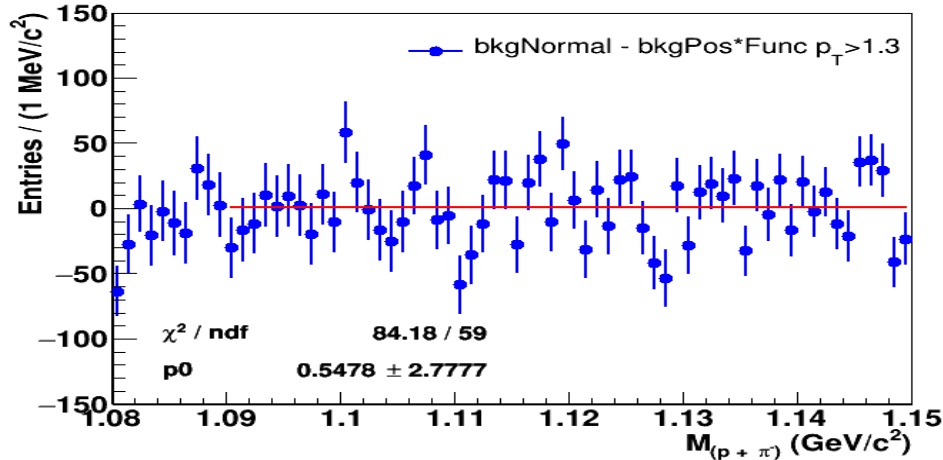
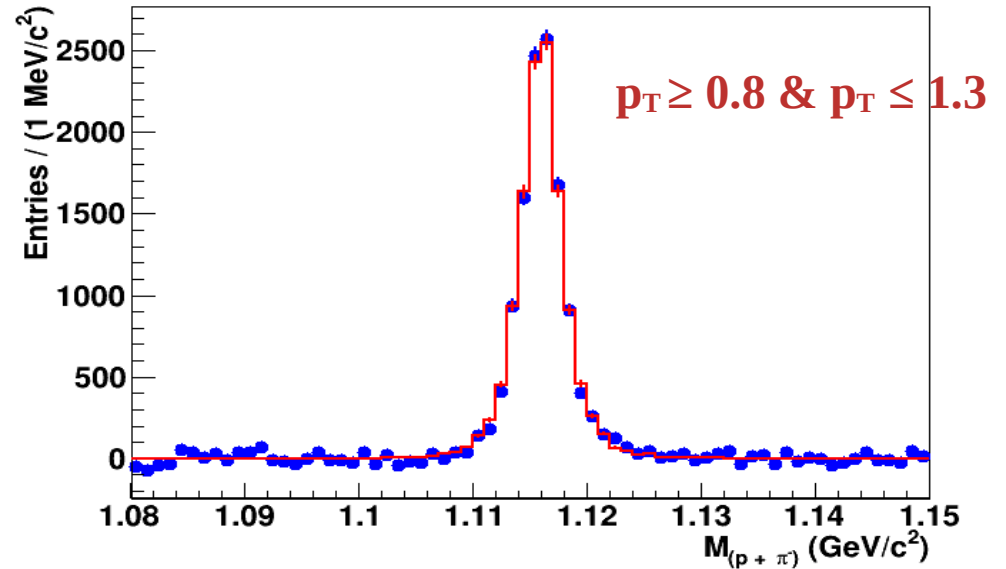
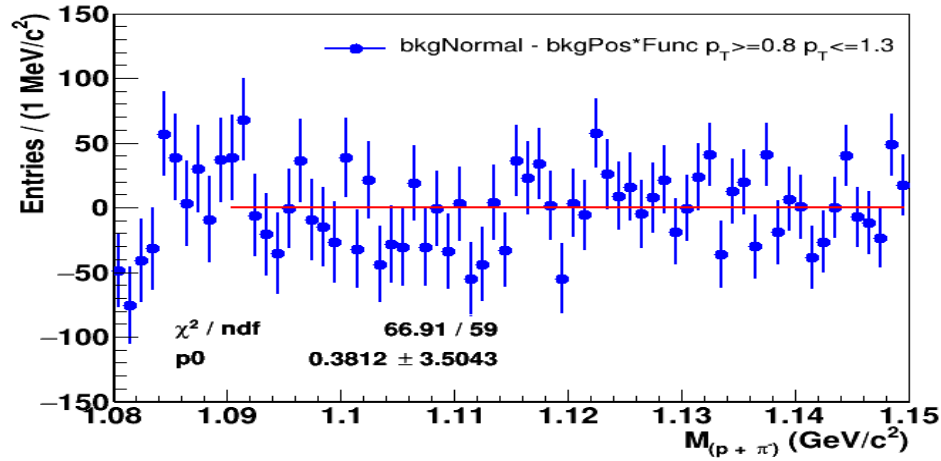

# Invariant mass( $p\pi$ ) and $\Lambda$ phase space of $p_T$

UrQMD, Bi+Bi @ 9.2 GeV, 20M events

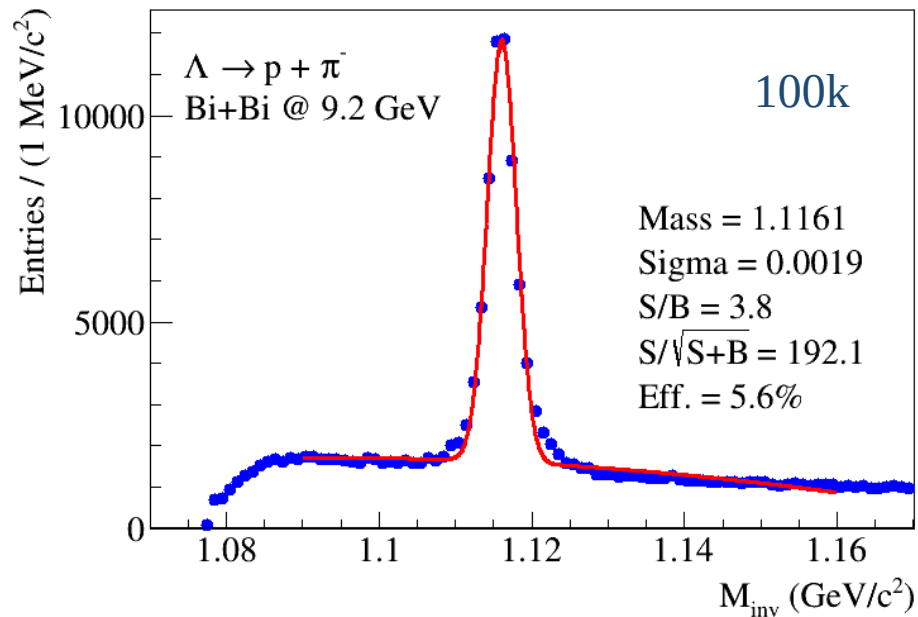

- ✓ **Reconstruction & Analysis:** hyperon wagon in the analysis train
- ✓ **PID:** no PID for protons @  $p_T > 2.5$  GeV/c
- ✓ **Selection:**  $|y| < 0.5$ ,  $Z_{PV} = \pm 130$  cm
- ✓ **Centrality bins:** 0-10%, 10-20%, 20-40%, 40-60%, 60-80%

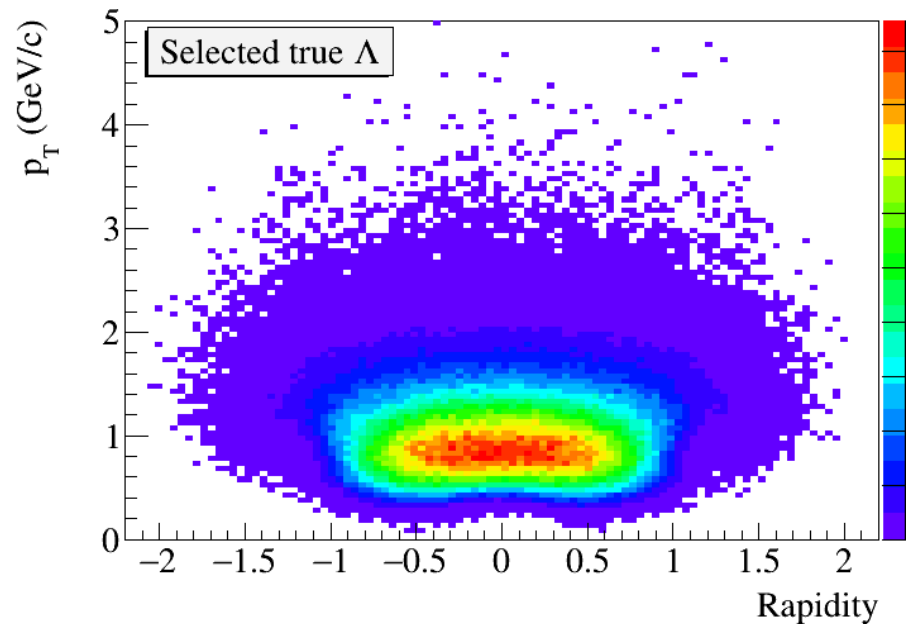

- ✓  $10.\text{chi2s}[[0]] > 8.0$  – normalized pion-to-primary vertex impact parameter
- ✓  $10.\text{chi2s}[[1]] > 5.0$  – normalized proton-to-primary vertex impact parameter
- ✓  $10.\text{chi2h} < 7.0$  – chi2 of secondary vertex reconstruction
- ✓  $10.\text{path} > 2.0$  – lambda decay path
- ✓  $10.\text{angle} < 0.08$  – lambda momentum and primary-to-secondary vertex vector noncollinearity

# Invariant mass( $p\pi$ ) in $p_T$ -bins for different centralities

UrQMD, Bi+Bi @ 9.2 GeV, 20M events

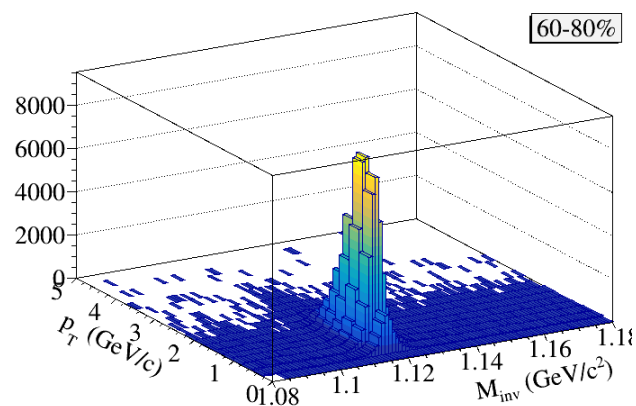
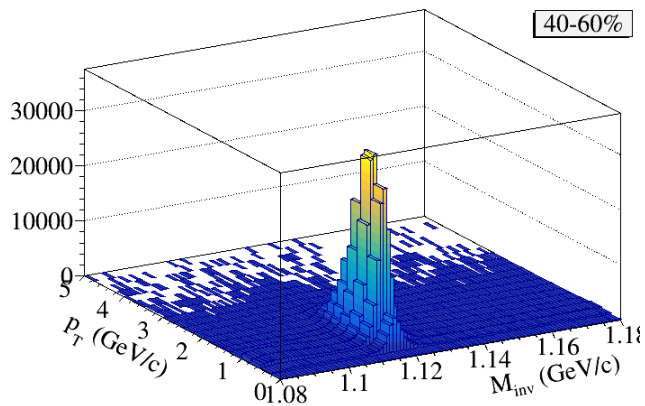
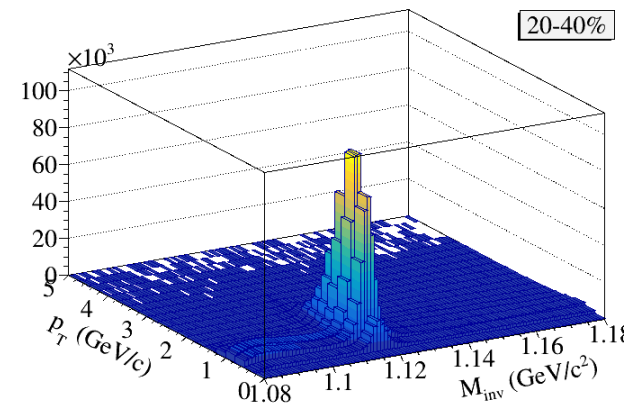
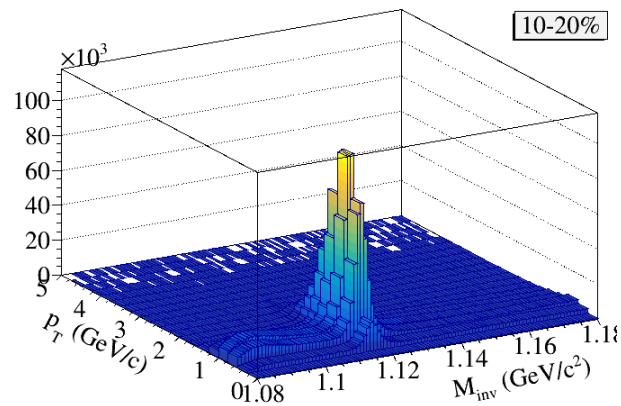
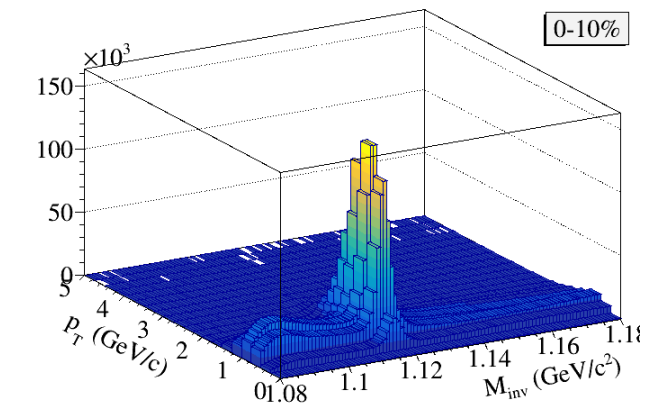



# Background subtraction: fitted or mixed

UrQMD, Bi+Bi @ 9.2 GeV, 20M events

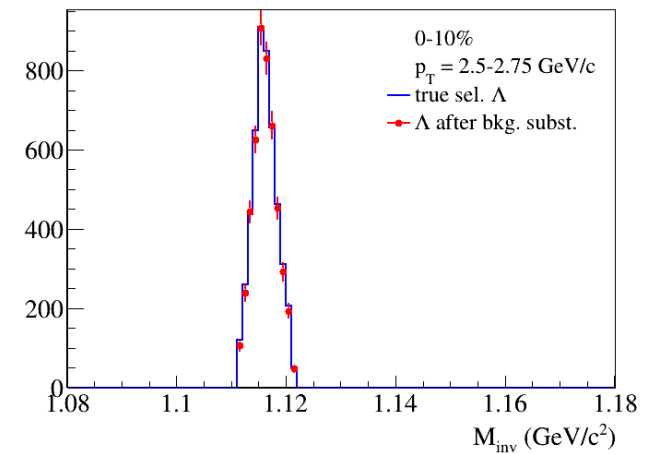
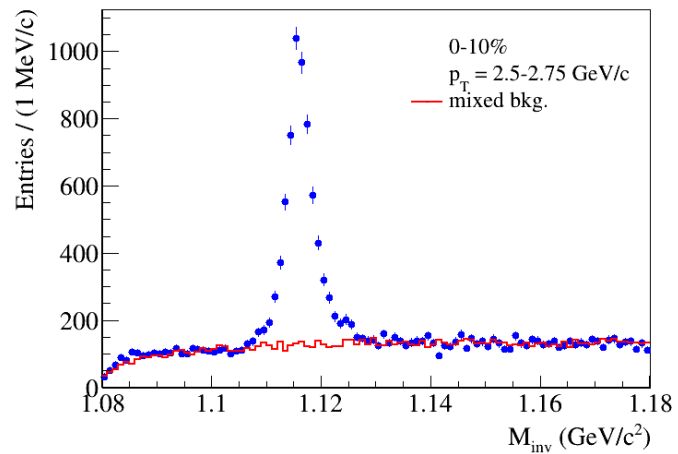
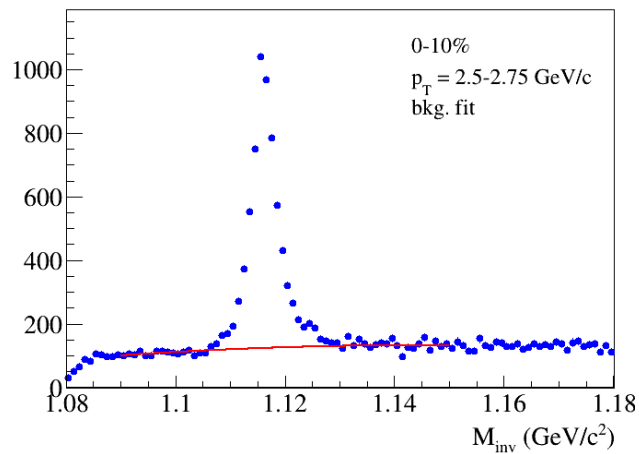
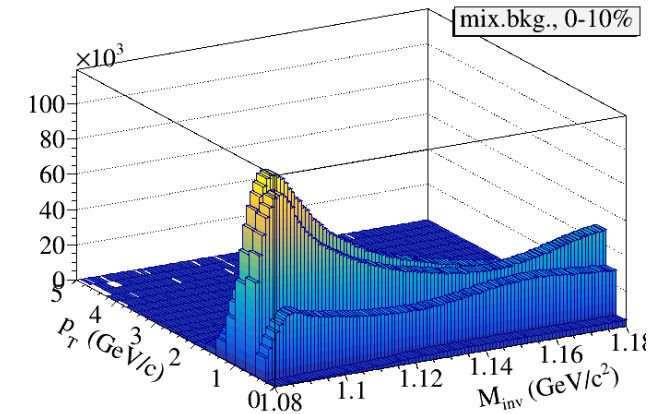
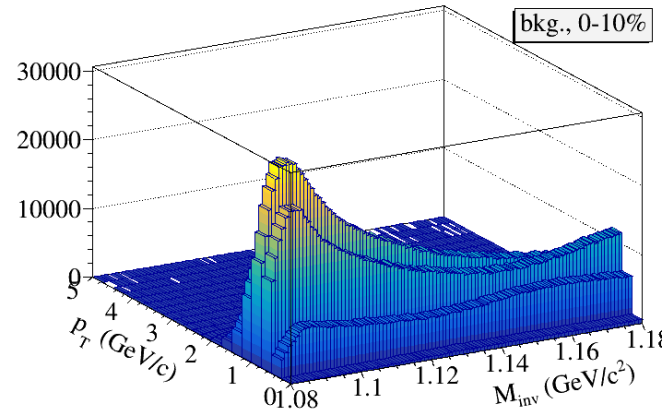
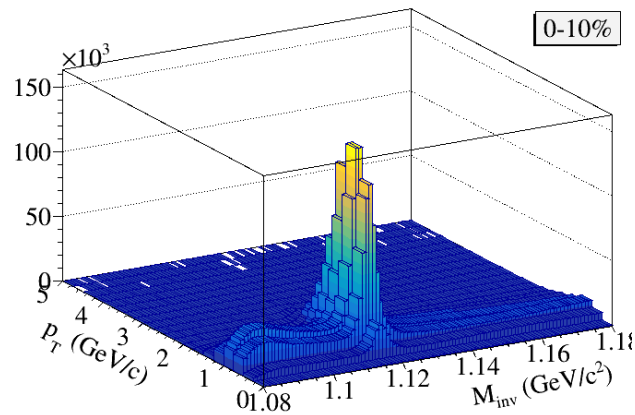

# Extracted-to-true signal ratio: fitted vs mixed background

UrQMD, Bi+Bi @ 9.2 GeV, 20M events

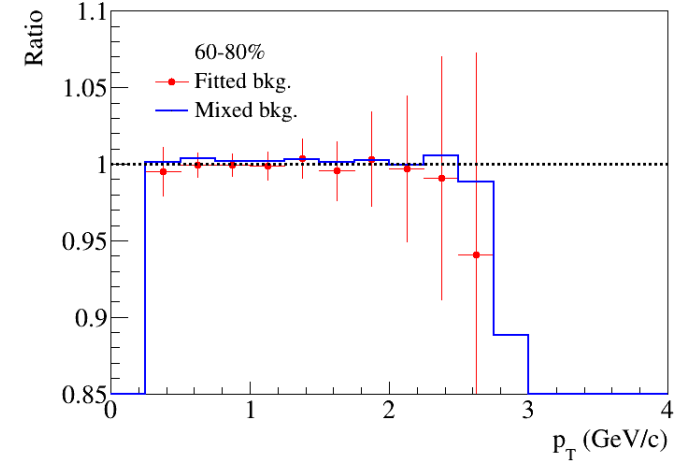
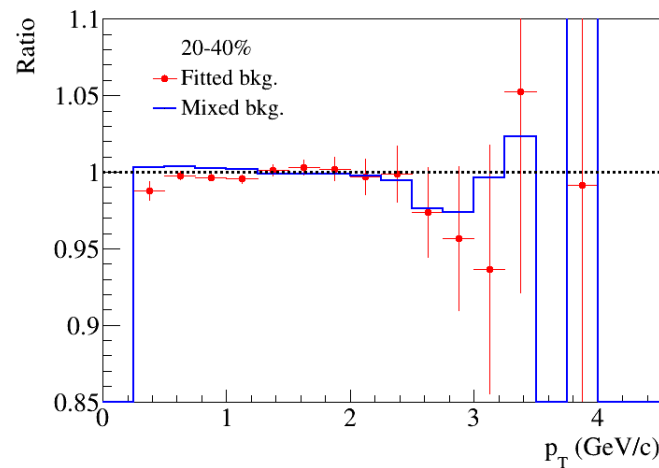
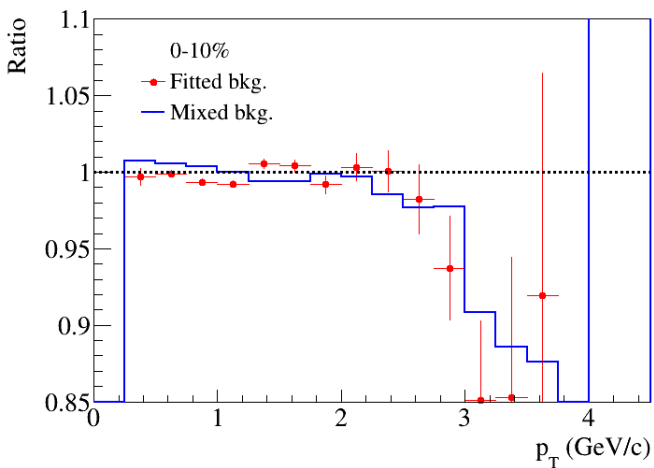
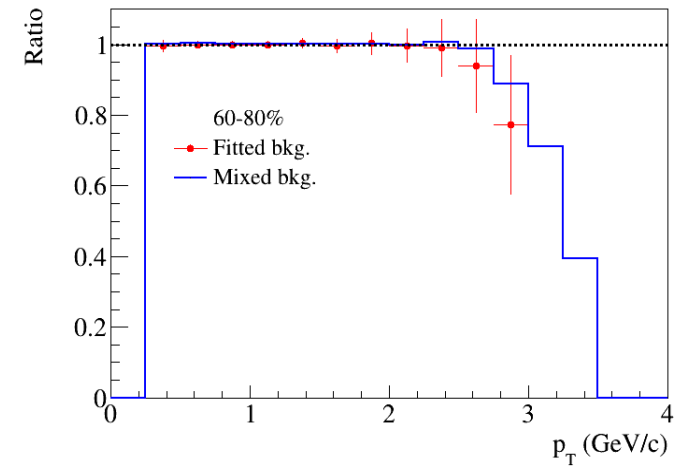
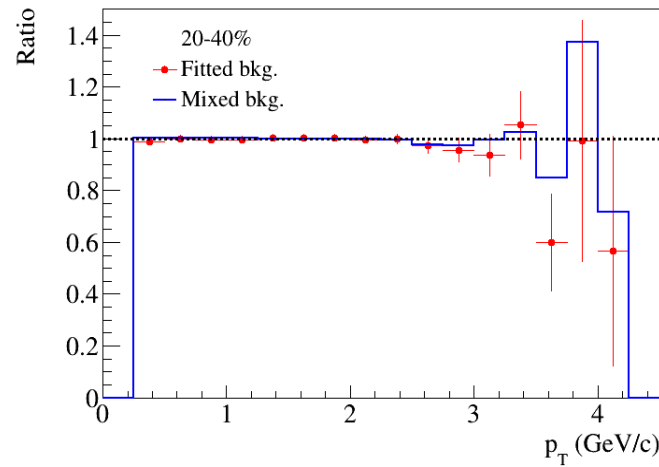
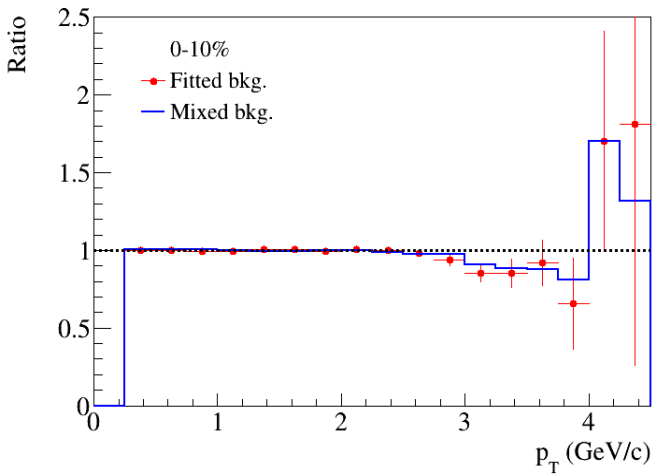

# Invariant $p_T$ -spectrum of $\Lambda$ in centrality bins

UrQMD, Bi+Bi @ 9.2 GeV, 20M events

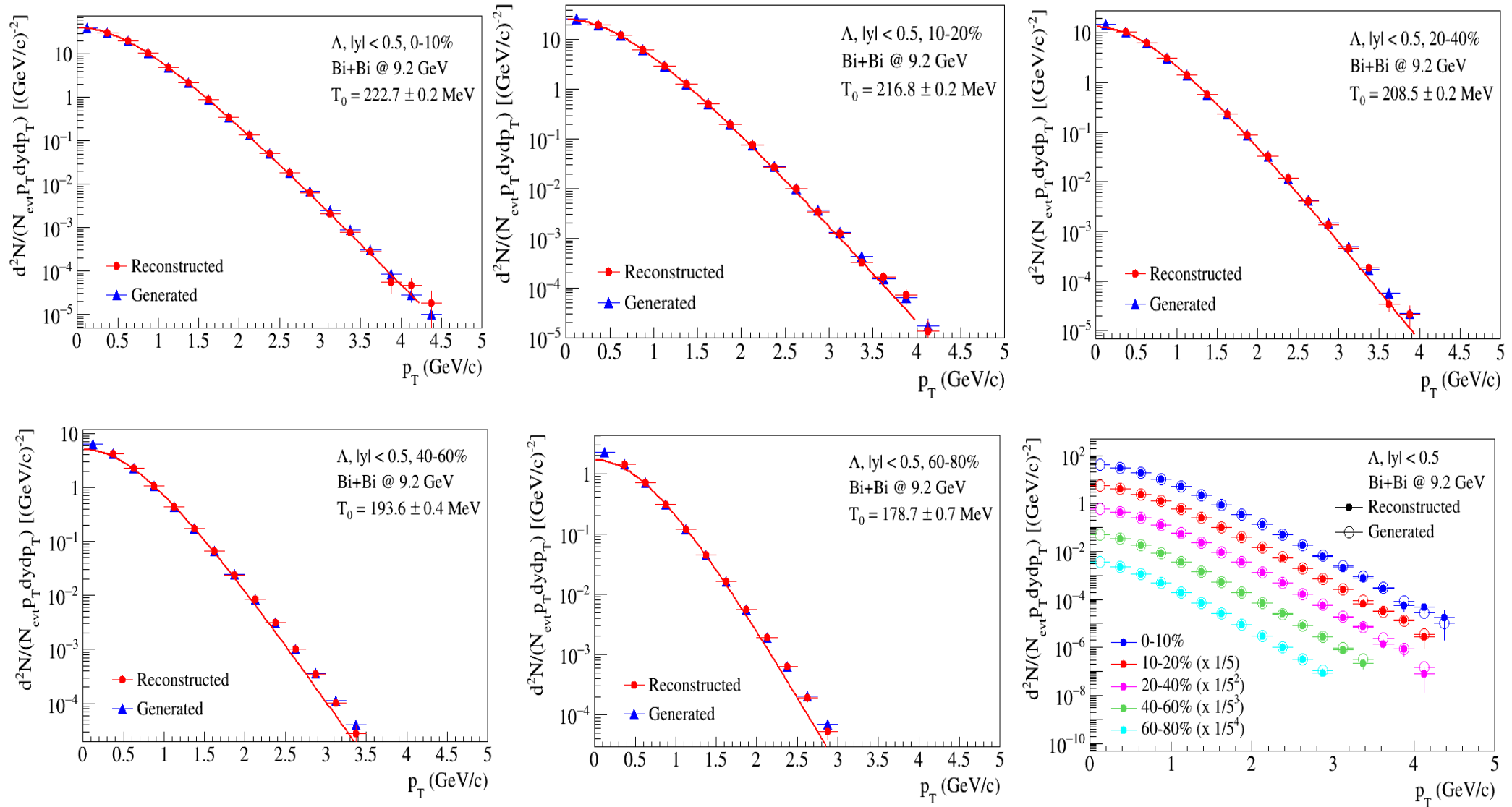

# Conclusions and outlook



- ✓ The procedures for estimation of the combinatorial background for lambda hyperon reconstruction based on event-mixing and like-sign pair combinations have been implemented and tested. The approach has been used to extract hyperon multiplicities in simulated event samples.
- ✓ Implement similar approaches for other hyperons and study another techniques based on track rotation.

**Thank you for your attention!**

# Backup

# Maximization of significance

1. Significance is defined as  $S/\sqrt{S+B}$ , where **S** and **B** are total numbers of signal and background combinations inside  $\pm 2\sigma$  interval around the peak position.
2. Set of 6 cuts for  $\Lambda$  selection:  $\chi^2_\pi$  ( $dca_1$ ),  $\chi^2_p$  ( $dca_2$ ),  $\chi^2_{v0}$ ,  $dca_{v0}$ , path, angle between  $\mathbf{p}$  and  $\mathbf{r}$  of  $\Lambda$ .
3. Variation of 6 cuts with small steps and production of invariant mass distributions for each set of cuts.
4. Fitting to the sum of gaussian and polynomial functions and computing the significance.
5. Selection of maximum significance with corresponding cuts (see Fig.).

While different physics analyses might prefer different selection quality criteria, the significance looks convenient to quantitatively evaluate effect of different factors on the reconstruction quality.

